

Prodotti da GRUPPO STAMPLAST questi articoli consentono una facile posa in opera di pavimenti galleggianti distribuendo i pesi in maniera regolare e favorendo allo stesso tempo la corretta ventilazione della copertura. Materiale: Materiale plastico rigenerato.

SUPPORT FOR TILES - SUPPORT FOR PANELS - LEVELLERS  
 Manufactured by GRUPPO STAMPLAST these articles allow an easy installation of floating floors distributing the weight properly and favoring at the same time the right ventilation of the subfloor.  
 Material: Regenerated plastic.

CALES SOUS TUILES, SUPPORT EGALISEUR SOUS PAVES

SOPORTE PARA BALDOS Y PARA CUADROS

# CAVALLOTTO / SUPPORTO PER QUADROTTI / LIVELLATORE

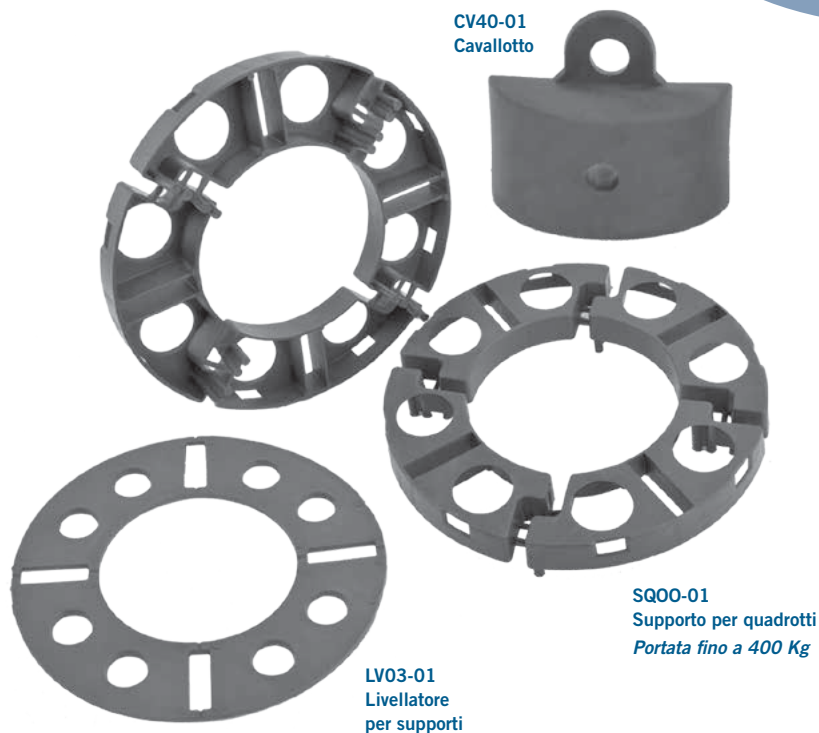

CV40-01  
Cavallotto





SQ00-01  
Supporto per quadrotti  
Portata fino a 400 Kg

LV03-01  
Livellatore  
per supporti

COLORI / COLORS



## SCHEDA ORDINE PRODOTTO / PRODUCT ORDER DATA SHEET

COD.	MOD.*					
CV40-01	Cavallotto	●	2000	96000	100x120x210	0,004 kg/pz
SQ00-01	Supporto	●	260	7280	100x120x210	0,032 kg/pz
LV03-01	Livellatore	●	500	30000	100x120x225	0,030 kg/pz

\*MEASURES IN CENTIMETERS

## SCHEDA TECNICA PRODOTTO / TECHNICAL SHEET

MOD.	A*	B*	C*	D*
Cavallotto	4,0	1,6	2,3	3,5
Supporto	15,2	2,7	1,4	4,0
Livellatore	15,2	8,0	0,3	--

\*MEASURES IN CENTIMETERS



Congiunzione supporti



Esempio di installazione

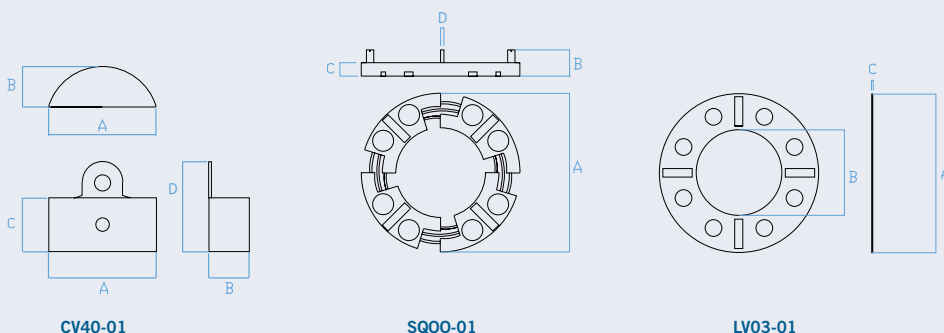

CV40-01

SQ00-01

LV03-01