

1 Utilizzo

Prodotto da GRUPPO STAMPLAST in ABS che garantisce a questo articolo un'eccellente resistenza ad agenti chimici, organici ed atmosferici. Disponibile anche con griglia in acciaio.

2 Modelli

COD.	MOD.*					
CH11TEL-02	11x11 Regolabile	●	16	1024	100x120x120	0,148 kg/pz
CH11TEL-02B	11x11 Regolabile	○	16	1024	100x120x120	0,148 kg/pz

*MEASURES IN CENTIMETERS



CH11TEL-02



ESPLOSO

Materiali
 ABS

Colori



3 Caratteristiche tecniche

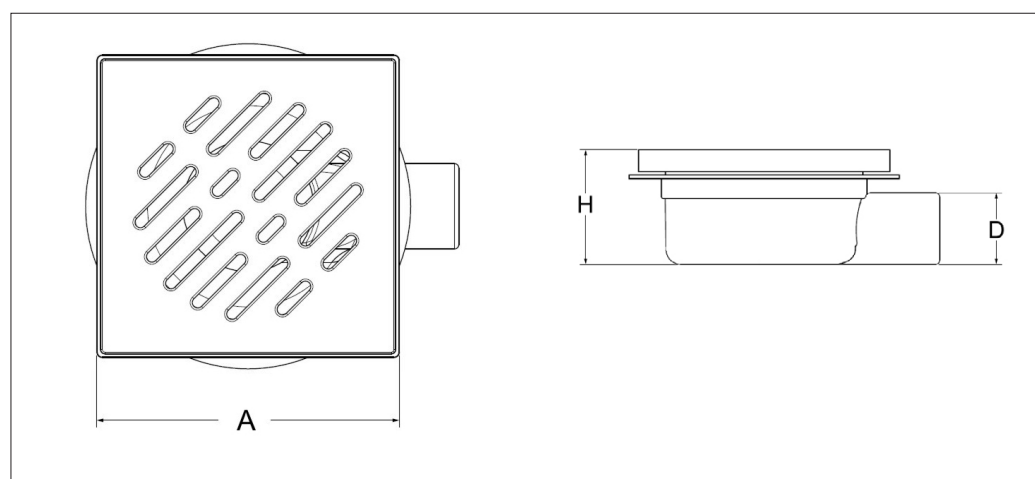

MOD.*	A*	D*	H*	HMAX*
11x11 Regolabile	107	40	64	69

*MEASURES IN MILLIMETERS



MADE IN ITALY

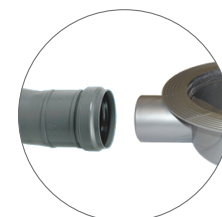

Raccordo Ø40mm

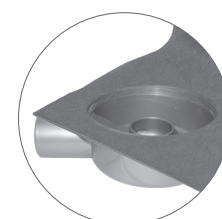

Montaggio con guaina

chiusino regolabile con griglia_11X11